

# RM-32 3G CONTROLLER TO RM-32D 4G CONTROLLER UPGRADE

This process can be done via the Data Sign Service Centres via our booking system - If location not suitable, a qualified auto electrical service provider can be used. Supporting documents will be required for warranty purposes.

This upgrade process utilises 'minimal' interference or removal of equipment and parts. With 'old' equipment, it is known that touching, removing and reinstating parts can result in 'other' things going wrong and having further issues to deal with. As this is outside our control, Data Signs does not accept responsibility for this.

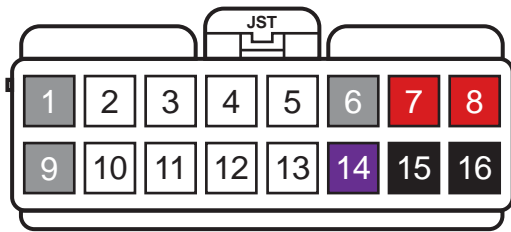

RADAR JST-4



OPTIONAL RADAR ADAPTOR

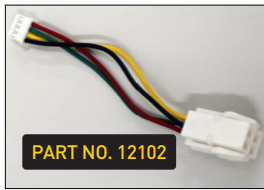

PART NO. 12102

OPTIONAL CONTROLLER BASE PLATE, BRACKET & LENS



Some sign controllers may need this bracket set.

Over time, the lens can darken which will reduce light output on sign. It is recommended to replace this.

OPTIONAL REPLACEMENT LENS

PART NO. 14711

## JST CONNECTOR – 16 PIN

Pin 1	Do not connect	<i>Colours may differ on some VMS Signs.</i>		
Pin 9	Do not connect			
Pin 2	Radar +VE 12 V <b>switched output</b>	<b>RED pin 1 Radar JST-4</b>		
Pin 10	Radar GND	<b>BLACK pin 4 Radar JST-4</b>		
Pin 3	Radar RS-232 TX	<b>YELLOW pin 3 Radar JST-4</b>		
Pin 11	Radar RS-232 RX	<b>GREEN pin 2 Radar JST-4</b>		
Pin 4	RS-232 TX output to Keyboard	<b>YELLOW</b>		
Pin 12	RS-232 RX input to Keyboard	<b>GREEN</b>		
Pin 5	Fan +VE 12V	<b>ONLY CONNECT TO FANS!</b>		
Pin 13	Fan GND		<b>RED Fig.8</b> <b>Black Fig.8</b>	
Pin 6	Do not connect			
Pin 14	*See Tamper & SHOW MESSAGE/BLANK SIGN function on last page			
Pin 7	+VE 12 Volts	Sign power input	<b>THICK RED</b> <b>THIN RED</b>	Looped in thin wire.
Pin 8	+VE 12 Volts	Sign power input		
Pin 15	GND	Sign Power input	<b>THICK BLACK</b> <b>THIN BLACK</b>	Looped in thin wire.
Pin 16	GND	Sign Power input		



OPTIONAL CONTROL PANEL  
PART NO. 12152 & 12266

Please view this video as part of the document.



Scan the QR code and select the "3G Controller Upgrade Process" video.



**Data Signs**  
AUSTRALIA  
Since 1976

[datasigns.com.au](http://datasigns.com.au)  
1300 850 785

## CONTROLLER UPGRADE INSTRUCTIONS

**1. BEFORE COMMENCING ANY WORK, remove ALL fuses from the batteries.**

- Remove the LED panel next to the controller, **carefully** unplug all ribbon cables and connectors and the aerial connectors from the controller.
- Remove the old controller. An optional base plate may be required to fit the new controller. **PART NO. 14710**

Take the SIM card out of the controller before it is discarded, this SIM card should be returned to your Telco to take it off the plan you are on as it is no longer needed.

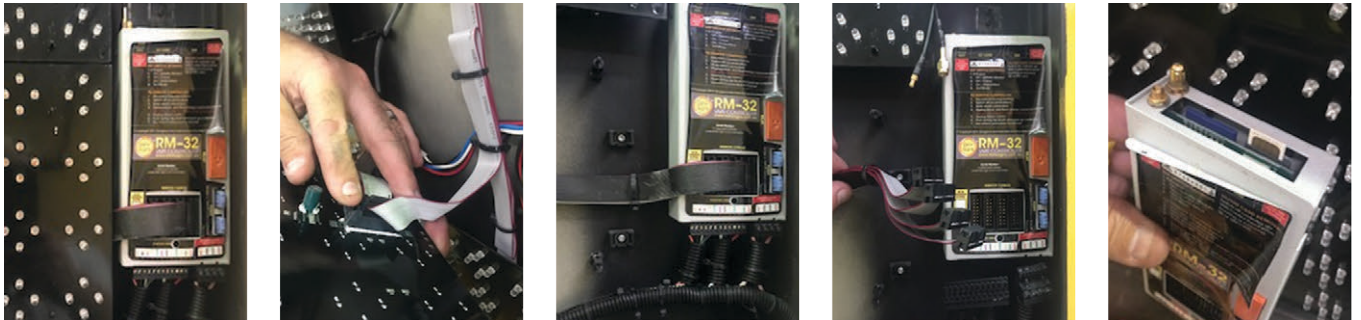

- If fitted, remove the small battery and micro switch inside sign head below controller and disconnect wires.
- Fit the New Controller (with the wiring harness fitted) into the sign and **carefully** plug the 4 Ribbon Cables back into the new Controller.
- Plug the original aerial wire into the right side aerial connector as shown. Cut off the small GPS cable and tie to the cable as shown.



- On the existing wiring harness, unscrew +Ve (red) wire on 4 way connector pin 1 and crimp to "12v DC Positive" labelled crimp connector of new wire harness.

Then unscrew -Ve (black) wire on 4 way connector pin 2 and crimp to "12v DC Negative" labelled crimp connector of new wire harness.

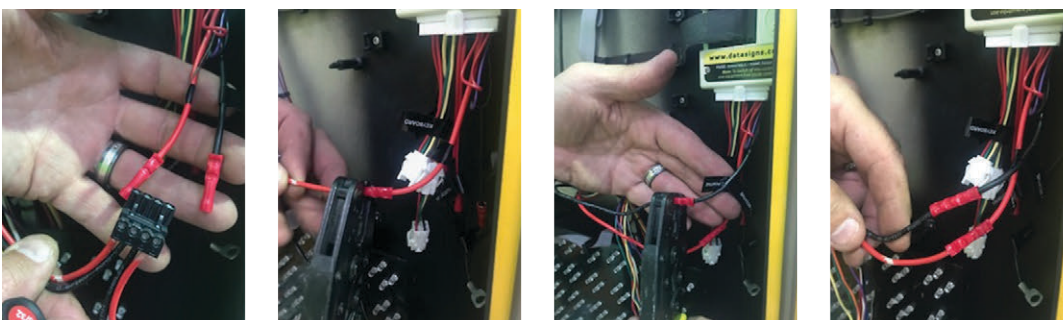



# RM-32 3G CONTROLLER TO RM-32D 4G CONTROLLER UPGRADE

8. On the existing old wiring harness, unscrew Fan -Ve (striped) wire from 14 way connector pin 2 and crimp to "Fan Negative" Labelled wire connector of new wire harness (the Negative wire has a black stripe on the actual wire).

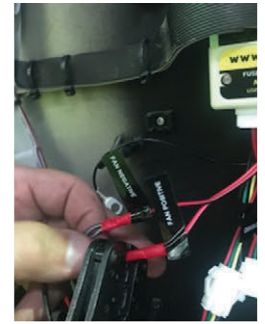
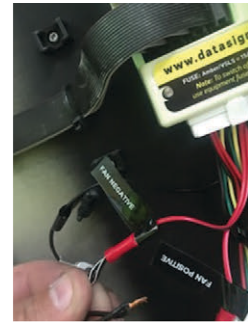
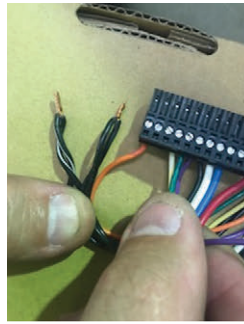

Then unscrew Fan +Ve (red) wire from 14 way connector pin 3 and crimp to "Fan Positive" Labelled connector of new wire harness.

9. Remove / cut back all other wiring from the 14 way connector.

- Tidy up all cables as shown



10. Installing aerial and 5m Cable: *Refer to Video.*

1. Remove top left panel
2. Mark, drill, seal and fit aerial
3. Route aerial cable
4. Fit to controller

11. Put LED panel back.

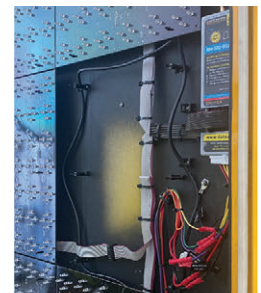
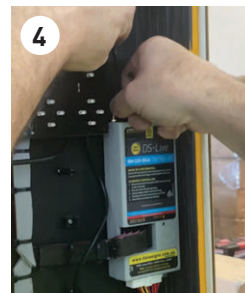
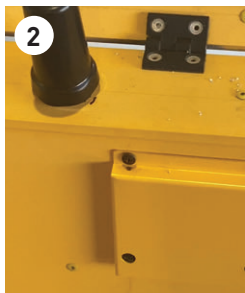
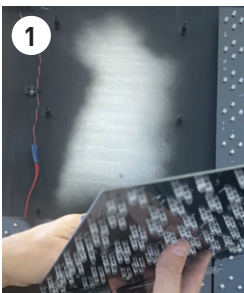

## IF A RADAR IS FITTED

Unplug 4 way connector and plug into new wiring harness connector.

Use the additional adaptor **PART NO. 12102** if required (if old style radar connector is fitted).



## RECOMMENDED REPLACEMENTS

If fan cover not fitted, replace fans and add cover. Fit new weather seal.

### FAN REPLACEMENT



### FAN COVERS



### SIGN HEAD SEAL TAPE



**YouTube**  
Watch YouTube "3G Controller Upgrade Process" video for these optional items and fitting the optional Control Panel

**Video times:** Fan: 3:23 / Seal Installation: 11:19 / Removing and Replacing Control Panel: 12:54

## OPTIONAL CONTROL PANEL WIRING INSTRUCTIONS

As the existing control panel is not compatible with the upgraded equipment, an optional control panel can be fitted to provide **SHOW MESSAGE / BLANK SIGN & HOIST Control (Part No. 12266)**

*If not fitted, the existing hoist control will still work but the SHOW or BLANK message will not work.  
This can be done via the DS-Live programming platform or Mobile VMS App.*

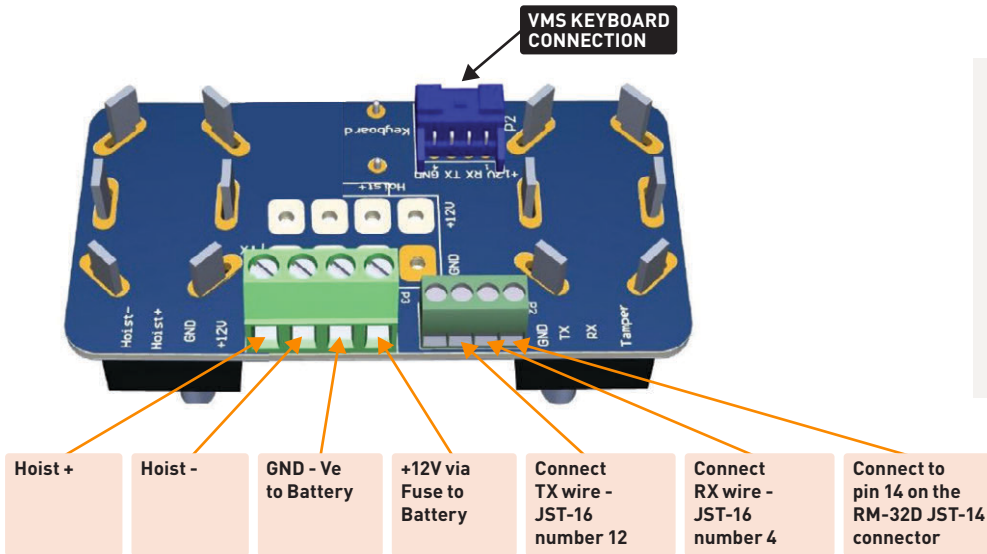

On very early models where the new control panel does not fit, a bracket with a label can also be supplied

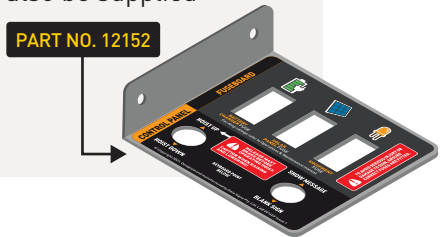

### WIRING FOR THE CONTROL PANEL IS AS PER BELOW.

There are 2 separate screw terminal connectors on this board, the larger one is for battery + & - input and the hoist control outputs.

1. Connect the +12V from the Battery via a Fuse 25Amp Rating.
2. If using a Hydraulic hoist system use the Hoist + for the Hoist lift solenoid and the Hoist - for the release valve  
\* The smaller terminal is used to connect the Tamper/Voltage & SHOW MESSAGE / BLANK SIGN line from the sign controller (pin 14 of the JST16 connector) and also the local keyboard TX and RX wires.

Connect wires as per below:

1. Tamper = wire connected to the JST pin 14 of the Sign Controller (Normally a Purple wire)
2. TX = Keyboard wire connected to the JST pin 4 of the Sign Controller (Normally a Yellow wire)
3. RX = Keyboard wire connected to the JST pin 12 of the Sign Controller (Normally a Green wire)

To connect the VMS Keyboard plug this into the 4 Pin connector fitted on the control board



**Adaptor for old style keyboard.**  
Use VELCRO to hold keyboard on shelf.  
Plug adaptor in when needing to use the keyboard.

## SIM CARD

A Data Signs SIM card is supplied and fitted in the new RM32D controller for connection to the DS-Live programming platform and for communications support and diagnostics.

Hand back the old Sim card to your previous service provider for credit or discard.

Go through the complete upgrade procedure again ensure everything is as per instructions. Re-insert fuses to power up the new controller.

The sign when switched on will be connected to the DS-Live™ platform. You can also use the AppVMS™ Mobile Phone App to control the sign.



APPENDIX

# OLDER CONTROLLERS & LED PANELS

Controller upgrades for signs older than 8 years are possible some of the time, however the following conditions apply:

- Controller upgrades that include having to change wiring harnesses, install new control and Fuse panels MUST have been carried out by a “qualified” Auto Electrician as a minimum or an Electronics Technician. Data Sign may require evidence of this. The cost for this is NOT covered by Data Signs or is part of the Upgrade cost.
- LED Boards must be compatible with your updated controller (*see examples below of Non Compatible LED Boards*), otherwise they must be replaced with current type LED Boards
- Solar Panels and Chargers have been tested and found to be in good operating order.
- It is recommed to have the batteries loadtested and found to be in good condition. Generally batteries older than 3-4 years should be replaced.

## RM-32 and RM-32B Controllers (signs older than 8 years)



The controller being replaced will retain the same Serial number and access to the DS-Live Platform.

A SIM Card is supplied and fitted in the new controller for connection to the DS-Live programming platform and for communications support and diagnostics.

The Controllers supplied by Data Signs are tested and are in good working condition when shipped, warranty however is conditional on properly installed upgraded signs as stipulated in this and other supplied documents. Damage caused to the controller due to conditions outside of Data Sign’s control is **NOT** covered & cost are not refundable.

## Examples of LED boards and Signs NOT SUITABLE for upgrades

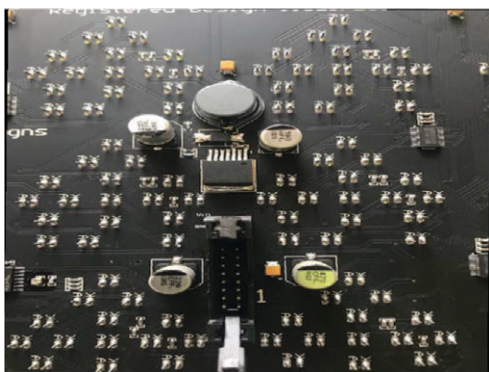

LED Boards fitted with DC-DC Circuit

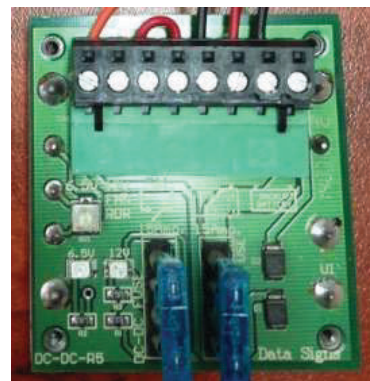

Controllers fitted with DC-DC convertors, either external or internal



**SIGNS FITTED WITH AMBER LED BOARDS MUST NEVER BE REPLACED OR UPGRADED WITH COLOUR LED BOARDS**